

**Please visit our
website to learn more:
www.kseindonesia.com**



PT. APINDO MITRA SELARAS

Unloading Valve

The unloading valve is commonly used in the pneumatic output system to continuously supply material to the conveying pipe. It can lock the air.

It can also be used in the material collection system as the unloading of the silo.

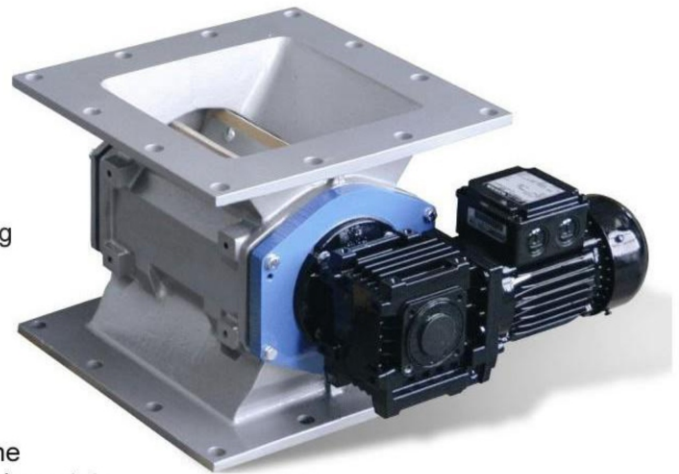

Function & Construction

When the material in the upper silo falls by its own weight and fills the gap between the blades, it is discharged at the lower part as the blades rotate. Therefore, the unloading valve can discharge quantitatively and continuously.

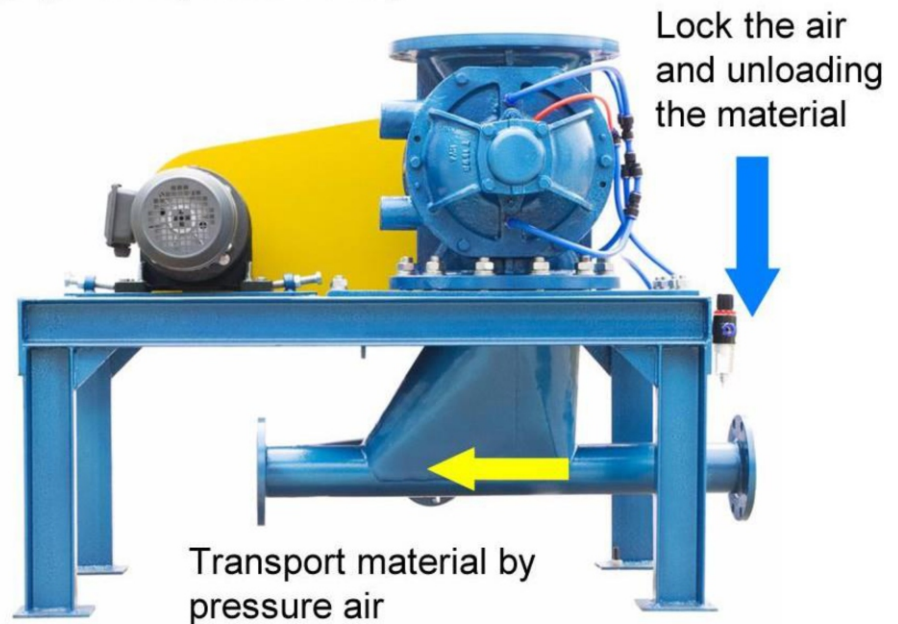

Usually the structure of the discharge valve is composed of a rotor impeller with several blades, shell, seal, reducer, and motor, etc.

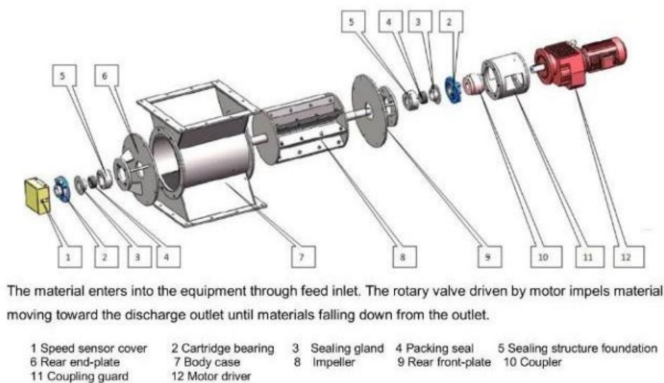

Unloading Valve

Features

- Wear-resistant enclosed rotor impeller
- Convenient to adjust the blade end
- Better sealing performance.
- High temperature resistance can reach 800 °C.
- Special form of unloader can be processed according to customer's drawings

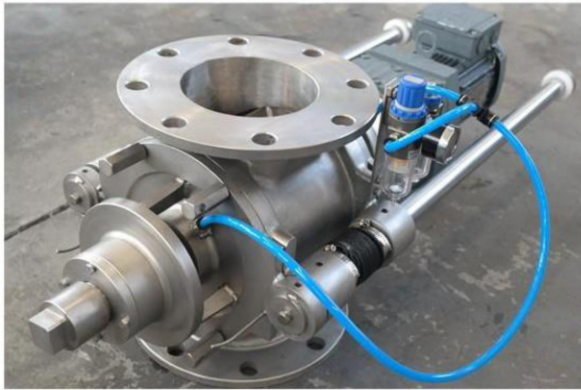
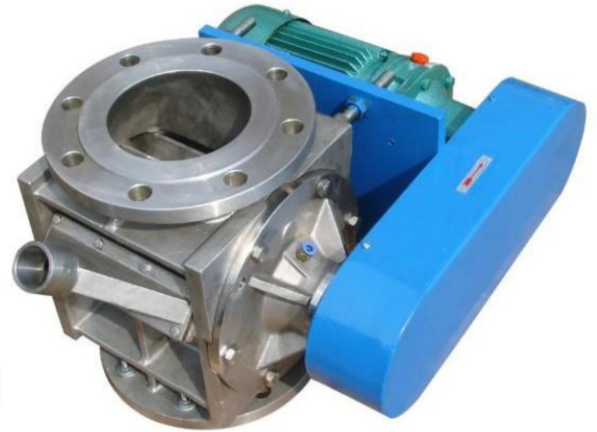

Impeller easy discharge & pressure air sealing



Pneumatic conveying & discharge in together



Good steel performance of impeller abrasion

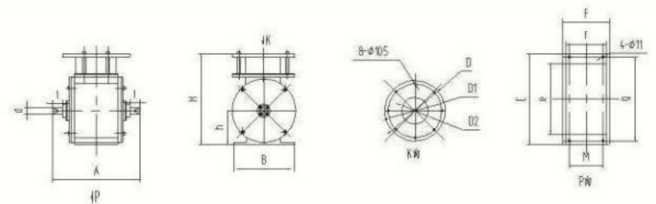

Processing according to customer's drawing



Unloading Valve

We can manufacture according to customer's drawing (OEM & ODM)

Popular type size information



B type Round flange

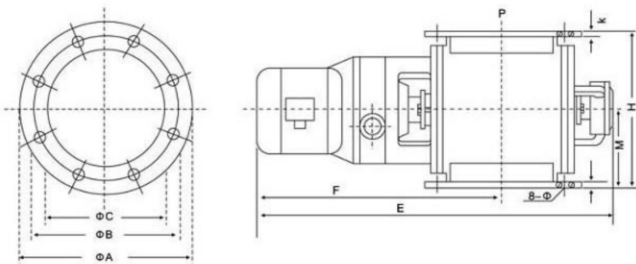

A type Square flange

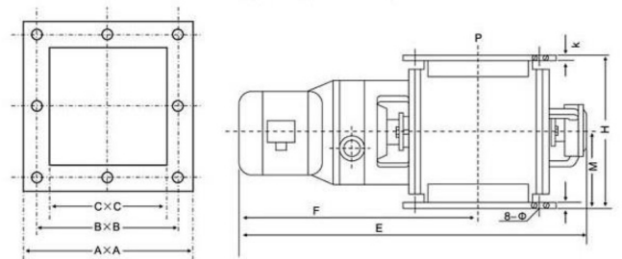

Dimension:

单位: mm

型号	ΦA	ΦB	ΦC	E	F	M	H	h	Φ
YJD02型	250	210	150	650	420	122.5	225	12	9
YJD04型	280	240	180	758	526	140	280	15	11
YJD06型	300	260	200	778	536	150	300	15	11
YJD08型	320	280	220	798	546	160	320	18	11
YJD10型	340	300	240	880	628	170	340	18	13
YJD12型	360	320	260	900	638	180	360	18	13
YJD14型	380	340	280	920	648	190	380	20	17
YJD16型	400	360	300	960	678	200	400	20	17
YJD18型	420	380	320	980	688	220	440	22	17
YJD20型	440	400	340	1000	698	230	450	22	17
YJD26型	500	460	400	1150	740	260	520	24	17
YJD30型	600	500	440	1190	755	280	600	24	17

型号	A	B	C	E	F	M	H	h	Φ
Φ300×450	440	390	300	1120	690	225	450	20	12-Φ22
Φ350×500	490	445	350	1200	700	250	500	25	12-Φ22
Φ400×500	520	480	400	1200	700	250	500	25	12-Φ22
Φ500×680	630	580	500	1500	1100	340	680	25	12-Φ22

Dimension:

单位: mm

型号	A	B	C	E	F	M	H	h	Φ
YJD02型	240	200	150	650	420	122.5	225	12	9
YJD04型	260	230	180	758	526	140	280	15	11
YJD06型	300	250	200	778	536	150	300	15	11
YJD08型	300	270	220	798	546	160	320	18	11
YJD10型	320	290	240	880	628	170	340	18	13
YJD12型	340	310	260	900	638	180	360	18	13
YJD14型	360	330	280	920	648	190	380	20	17
YJD16型	400	350	300	960	678	200	400	20	17
YJD18型	400	370	320	980	688	220	440	22	17
YJD20型	420	390	340	1000	698	230	450	22	17
YJD26型	500	450	400	1150	740	260	520	24	17
YJD30型	600	490	440	1190	755	280	600	24	17

型号	A	B	C	E	F	M	H	h	Φ
300×450	440	395	300	1120	690	225	450	20	12-Φ18
300×460	400	360	300	1090	680	230	460	20	12-Φ18
300×500	400	360	300	1090	680	300	500	20	12-Φ18
400×600	550	500	400	1300	960	300	600	20	12-Φ18
400×600	530	480	400	1400	1000	300	600	25	12-Φ18
500×680	630	585	500	1510	1100	340	680	25	12-Φ18

We have worked many years in this field, so we have many experience and we can provide the professional recommendation and suggestion for you. Our products are sold domestically and also exported to nearly 20 countries and regions, including Japan, Korea, Singapore, Australia, USA, Brazil, Russia, Portugal, India, Vietnam, Bangladesh.

Look forward to cooperate with you!!

Unloading Valve

Our processing

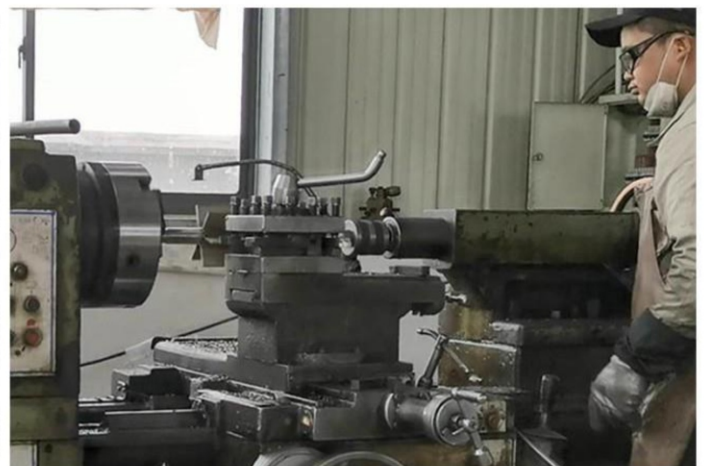

Unloading Valve

Our warehouse



Unloading Valve

Our delivery



AMS-KSEIndonesia Corp

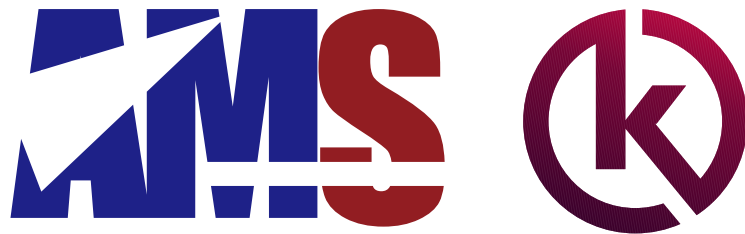

PT. APINDO MITRA SELARAS

Serang Office :

Komp. Lebak Indah Griya Asri
Blok D4-D5 No.17 & No.05
Waringin Kuring - Kramatwatu
Serang, Banten
42161

Cilegon Office :

Jl. Raya Pondok Cilegon Indah
Ruko Cilegon City Square Blok I No.7
Kedaleman - Cibeer
Cilegon, Banten
42422

Workshop :

Jl. Sultan Syahrir Kubang Sepat
Citangkil No. 105
Cilegon, Banten
42441

aris@kseindonesia.com - sales@kseindonesia.com - cso@kseindonesia.com

www.kseindonesia.com